

What India has to do?



ARAVIND KUMAR CHANDIRAN

ASSOCIATE PROFESSOR, DEPARTMENT OF CHEMICAL ENGINEERING

LEAD, HYDROGEN VALLEY INNOVATION CLUSTER - TAMIL NADU

EMAIL: ARAVINDKUMAR@IITM.AC.IN; TWITTER: [@ARAVINDIITM](https://twitter.com/ARAVINDIITM)

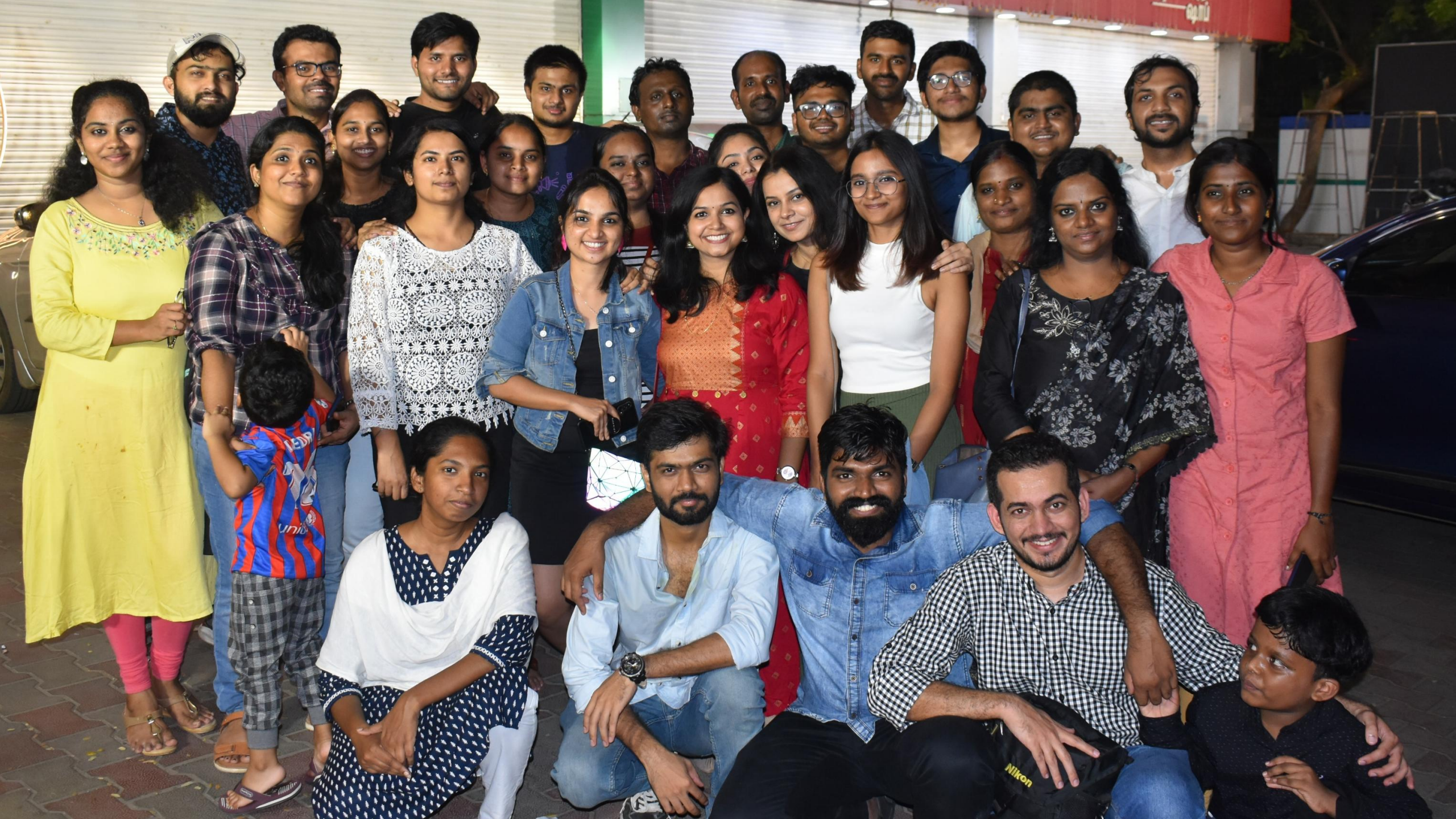

Mature
Technology

TRL 5

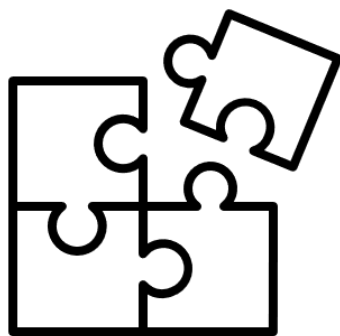

Integration &
Implementation

3

Technology
at Lab

TRL 3-4

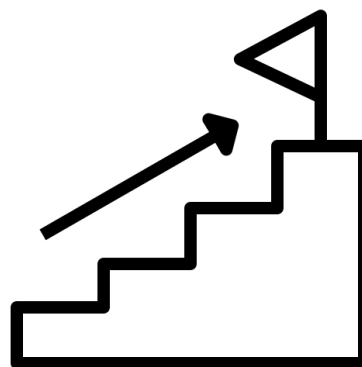

Scale-up

2

Exploratory

TRL 0-2



Materials, devices
and new concepts

1

Advanced
Technology

TRL 5

Grid independent
building

3

Technology
at Lab

TRL 3-
4

Zinc-air
batteries

Battery
Thermal
Runaway
setup

2

Exploratory

TRL 0-
2

Electric/magnetic
polarization
photoelectrochemis-
try

PEC water splitting

1

Strategies to achieve net zero by 2047

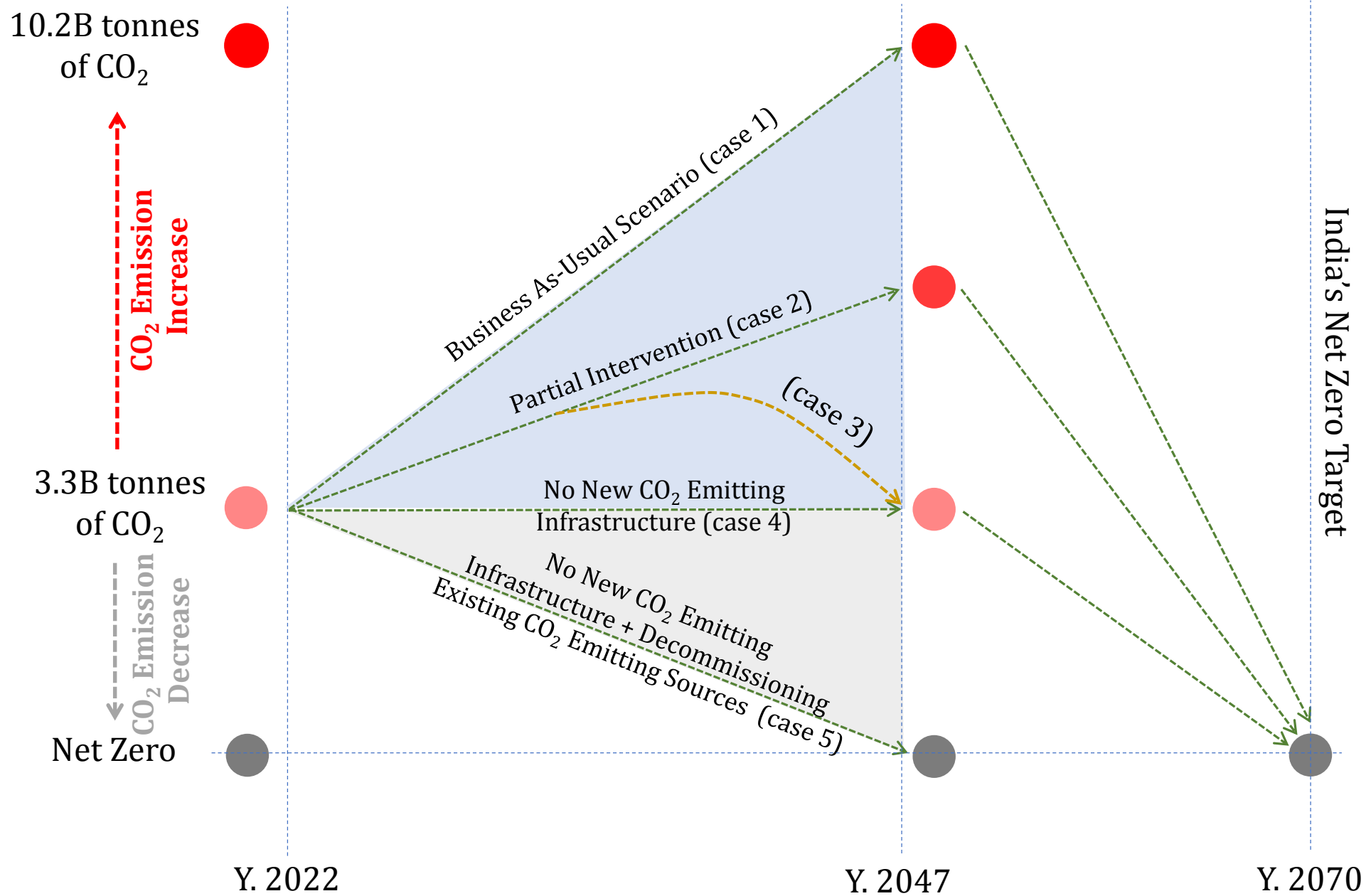

Case 1 is detrimental to environment

Case 2 is a partial intervention by 2047 and may require very serious intervention after 2047

Case 3 is serious partial intervention with de-slope of emission before 2047

Case 4 essentially cut off any emission from new infrastructure but impossible

Case 5 is immediate deslope and is difficult to

Month	Programme	Agency
Feb 2022	Green Hydrogen Policy	Ministry of Power
June 2022	Harnessing Green Hydrogen: Opportunities for Deep Decarbonisation in India	Niti Aayog
Sept 2022	Creation of Hydrogen Valley Innovation Clusters	Department of Science & Technology
Jan 2023	National Green Hydrogen Mission	Ministry of New and Renewable Energy
June 2023	Strategic Intervention for Green Hydrogen Transition (SIGHT): Incentive Scheme for Electrolyzer Manufacturing	Ministry of New and Renewable Energy (Implementing agency: SECI)
June 2023	Strategic Intervention for Green Hydrogen Transition (SIGHT): Incentive Scheme for Green Hydrogen Production	Ministry of New and Renewable Energy (Implementing agency: SECI)
July 2023	R&D Roadmap for Green Hydrogen Ecosystem in India	Ministry of New and Renewable Energy

Hydrogen Valley Innovation Cluster - DST



National Green Hydrogen Mission

EXPECTED OUTCOMES OF THE MISSION BY 2030

India's Green Hydrogen Production Capacity will Reach at Least
5 MMT Per Annum



Renewable Energy Capacity Addition of
~125 GW



Over
₹8 lakh crore
in Total Investments



Create Over
6 lakh
Full Time Jobs



50 MMT
per annum
of CO2 Emissions
are Expected to be Averted





Hydrogen Valley Platform in Tamil Nadu



Generation

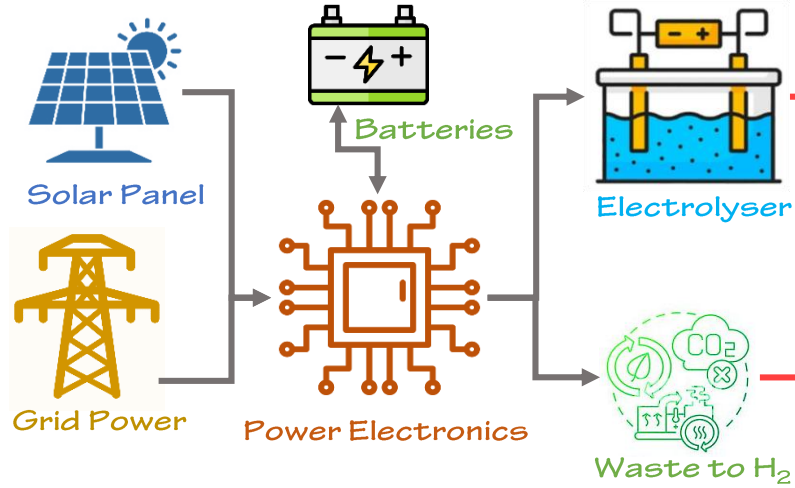

Storage

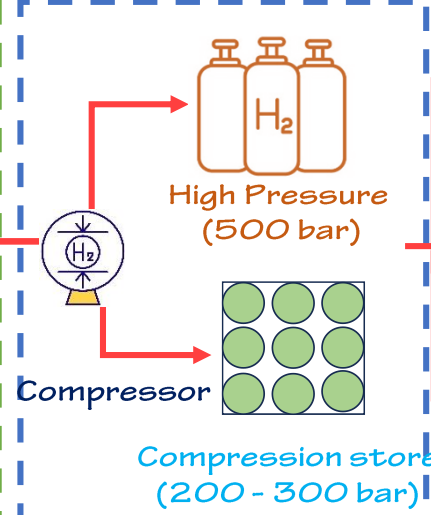

Transport & Utilization

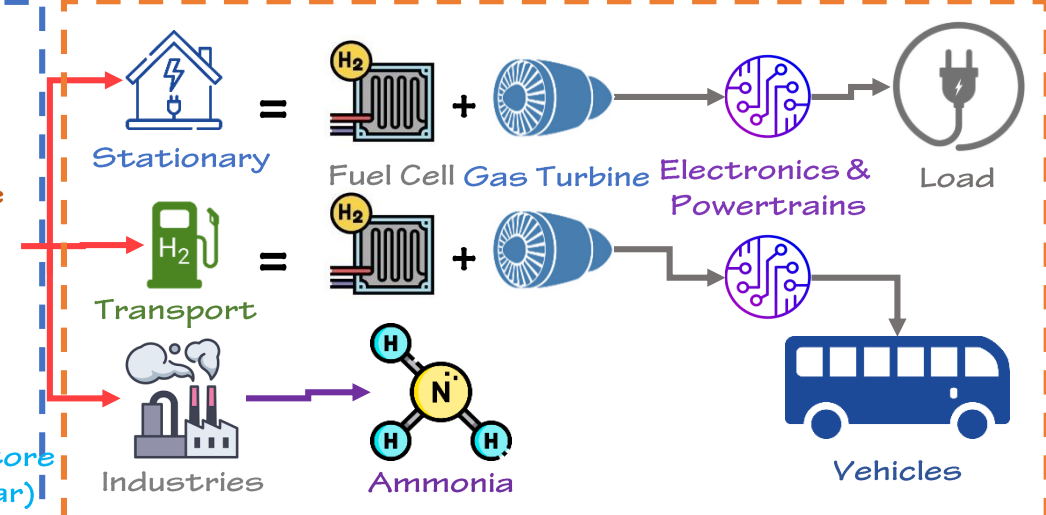

Partners

Outcomes





*HVIC - TN Stakeholders'
Meet Sept '23*



*Green Hydrogen Roundtable
Oct '23*

Strategy

Focus on existing strengths. Reroute to meet nation's goals (manufacturing, skilled human resource, MSME ecosystem, IT ecosystem)

Develop new strengths (mid-range research)

Curiosity driven research (long-range research)

Visions of Hydrogen Valley Innovation Cluster in Tamil Nadu

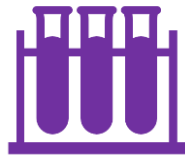

Best R&D hub in the world for green hydrogen research



Modular test rig for prototype evaluation



Localization of manufacturing & validation Centre



Policy advocacy



Skill Development



Incubators

Thank You!